



Description

TFV series consists of Metal Oxide Varistor&Thermal Protection Element. The built-in thermal protection element can quickly respond to the Over-temperature of the varistor to provide instant protection.The integrated struduce of TFV has lower inductance and better ability to suppress surge and overvoltage .

SETsafe | SETfuse thermal protected pressure-sensitive resistor (TFV) product operating voltage coverage of 50 ~ 510 VAC, Nominal Discharge Current :2.5 kA, Max. Peak Current :5 kA, safety certification includes: UL, cUL, TUV, CQC, and complies with 10oHS and REACH.



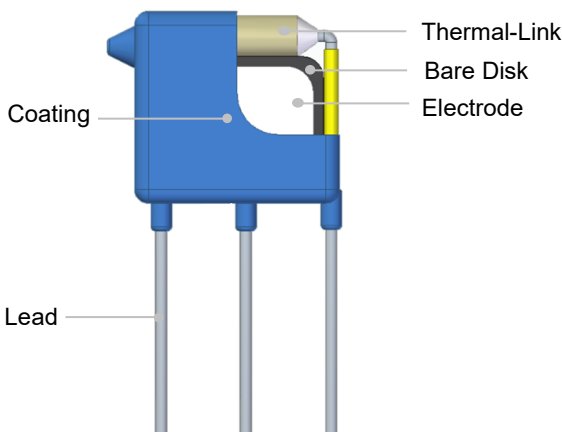

Product Structure



Features

- Patented Product
- Thermal Protection Varistor
- Thermal Protection Elements Are Built In To Save Space
- Three-lead Version Available For Indication Purpose
- Low Leakage
- Operatin Temp. Range:(-40 to 105)°C
- RoHS & REACH Compliant

Agency Approvals

Agency	Standards	File No.
	UL 1449 4 th Edition	E322662
	CSA C22.2 NO.269.5-17	E322662
	EN IEC 61051-1:2018 IEC 61051-2:1991+A1 IEC 61051-2-2:1991 Annex G.8.1, G.8.2 of IEC 62368-1:2018	J 50554091
	GB/T 10193-1997 GB/T 10194-1997 GB 4943.1-2022 IEC 61051-2:1991+Amd1:2009	CQC23001391361

Applications

- Power Supplies
- Home Electrical Appliances
- Industrial Devices
- Surge Protectors
- Telecom Devices
- AC Panel Protection Modules
- AC Power Meters
- GFCI (Ground Fault Current Interrupter)
- UPS (Uninterruptable Power Supply)
- Inverters

Marking

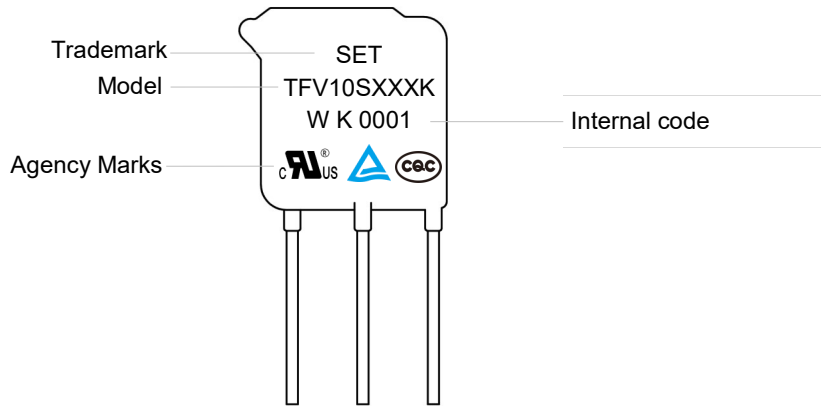

Temp. Derating Curve

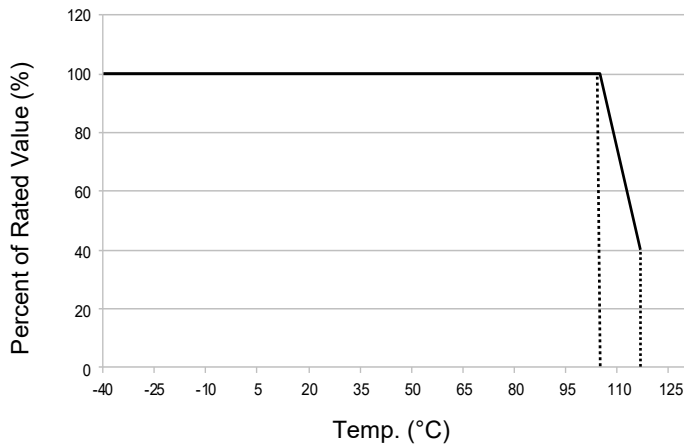

Note:
When ambient Temp. exceeds 105 °C, the peak surge current and energy rating should be reduced as shown in left curve.

105 °C For Normal Temp. Series

General Technical Data

Item	Value	Unit
Operating Temperature	-40 to +105	°C
Storage Temperature	-40 to +125	°C
Voltage Proof	≥2500	V _{ac}
Insulation Resistance	≥100	MΩ

TFV

Thermal Fuse Varistor

TFV10S Series

Dimensions (mm)

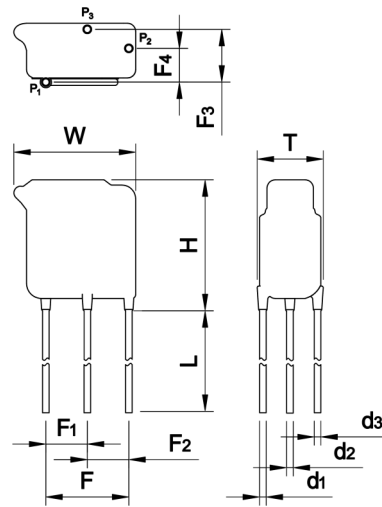





Model	L (Min.)	W (Max.)	H (Max.)	T (Max.)	d ₁	d ₂	d ₃	F	F ₁	F ₂	F ₃	F ₄
TFV10S820	15	16.5	18	4.4	0.80±0.05	0.80±0.05	0.80±0.05	/	5.0±0.5	5.0±0.5	1.2 ~ 2.6	0.4 ~ 1.8
TFV10S101	15	16.5	18	4.6	0.80±0.05	0.80±0.05	0.80±0.05	/	5.0±0.5	5.0±0.5	1.3 ~ 2.8	0.5 ~ 1.9
TFV10S121	15	16.5	18	4.8	0.80±0.05	0.80±0.05	0.80±0.05	/	5.0±0.5	5.0±0.5	1.4 ~ 3.0	0.6 ~ 2.0
TFV10S151	15	16.5	18	5.1	0.80±0.05	0.80±0.05	0.80±0.05	/	5.0±0.5	5.0±0.5	1.5 ~ 3.3	0.8 ~ 2.2
TFV10S181	15	16.5	18	4.5	0.80±0.05	0.80±0.05	0.80±0.05	/	5.0±0.5	5.0±0.5	1.3 ~ 2.8	0.5 ~ 1.9
TFV10S201	15	16.5	18	4.6	0.80±0.05	0.80±0.05	0.80±0.05	/	5.0±0.5	5.0±0.5	1.4 ~ 2.9	0.6 ~ 2.0
TFV10S221	15	16.5	18	4.7	0.80±0.05	0.80±0.05	0.80±0.05	/	5.0±0.5	5.0±0.5	1.5 ~ 3.0	0.6 ~ 2.0
TFV10S241	15	16.5	18	4.8	0.80±0.05	0.80±0.05	0.80±0.05	/	5.0±0.5	5.0±0.5	1.6 ~ 3.1	0.7 ~ 2.1
TFV10S271	15	16.5	18	5.0	0.80±0.05	0.80±0.05	0.80±0.05	/	5.0±0.5	5.0±0.5	1.7 ~ 3.3	0.8 ~ 2.2
TFV10S301	15	16.5	18	5.2	0.80±0.05	0.80±0.05	0.80±0.05	/	5.0±0.5	5.0±0.5	1.8 ~ 3.5	0.8 ~ 2.2
TFV10S331	15	16.5	18	5.4	0.80±0.05	0.80±0.05	0.80±0.05	/	5.0±0.5	5.0±0.5	1.9 ~ 3.6	0.9 ~ 2.3
TFV10S361	15	16.5	18	5.6	0.80±0.05	0.80±0.05	0.80±0.05	/	5.0±0.5	5.0±0.5	2.0 ~ 3.8	1.0 ~ 2.4
TFV10S391	15	16.5	18	5.7	0.80±0.05	0.80±0.05	0.80±0.05	/	5.0±0.5	5.0±0.5	2.0 ~ 4.0	0.9 ~ 2.9
TFV10S431	15	16.5	18	6.0	0.80±0.05	0.80±0.05	0.80±0.05	/	5.0±0.5	5.0±0.5	2.2 ~ 4.2	0.5 ~ 2.5
TFV10S471	15	16.5	18	6.2	0.80±0.05	0.80±0.05	0.80±0.05	/	5.0±0.5	5.0±0.5	2.4 ~ 4.4	0.6 ~ 2.6
TFV10S511	15	16.5	18	6.4	0.80±0.05	0.80±0.05	0.80±0.05	/	5.0±0.5	5.0±0.5	2.6 ~ 4.6	0.7 ~ 2.7
TFV10S561	15	16.5	18	6.7	0.80±0.05	0.80±0.05	0.80±0.05	/	5.0±0.5	5.0±0.5	2.9 ~ 4.9	0.8 ~ 2.8
TFV10S621	15	16.5	18	7.1	0.80±0.05	0.80±0.05	0.80±0.05	/	5.0±0.5	5.0±0.5	3.2 ~ 5.2	1.0 ~ 3.0
TFV10S681	15	16.5	18	7.4	0.80±0.05	0.80±0.05	0.80±0.05	/	5.0±0.5	5.0±0.5	3.6 ~ 5.6	1.1 ~ 3.1
TFV10S751	15	16.5	18	7.9	0.80±0.05	0.80±0.05	0.80±0.05	/	5.0±0.5	5.0±0.5	4.0 ~ 6.0	1.3 ~ 3.3
TFV10S821	15	16.5	18	8.3	0.80±0.05	0.80±0.05	0.80±0.05	/	5.0±0.5	5.0±0.5	4.4 ~ 6.4	1.5 ~ 3.5

Note:

The above data is for reference only.

Specification

Model	Max. Continuous Operating Voltage		Varistor Voltage @1 mA DC		Clamping Voltage (Max.)		Max. Discharge Current (8/20 μs)		Max. Energy (10/1000 μs)	Typical Capacitance (For reference only) @1 kHz	Agency Approvals			
	VAC	VDC	Min.	Max.	V _C	I _P	I _n	I _{max}	(J)	(pF)				
	(V)	(V)	(V)	(V)	(V)	(A)	(kA)	(kA)			UL	cUL	TUV	CQC
TFV10S820K	50	65	74	90	135	50	2.5	5	27	2400	●	●	●	●
TFV10S101K	60	85	90	110	165	50	2.5	5	33	2000	●	●	●	●
TFV10S121K	75	100	108	132	200	50	2.5	5	40	1700	●	●	●	●
TFV10S151K	95	125	135	165	250	50	2.5	5	53	1300	●	●	●	●
TFV10S181K	115	150	162	198	300	50	2.5	5	60	1100	●	●	●	●
TFV10S201K	130	170	180	220	340	50	2.5	5	70	1000	●	●	●	●
TFV10S221K	140	180	198	242	360	50	2.5	5	78	900	●	●	●	●
TFV10S241K	150	200	216	264	395	50	2.5	5	84	830	●	●	●	●
TFV10S271K	175	225	243	297	455	50	2.5	5	99	740	●	●	●	●
TFV10S301K	190	250	270	330	500	50	2.5	5	108	670	●	●	●	●
TFV10S331K	210	275	297	363	550	50	2.5	5	115	610	●	●	●	●
TFV10S361K	230	300	324	396	595	50	2.5	5	130	560	●	●	●	●
TFV10S391K	250	320	351	429	650	50	2.5	5	140	510	●	●	●	●
TFV10S431K	275	350	387	473	710	50	2.5	5	155	460	●	●	●	●
TFV10S471K	300	385	423	517	775	50	2.5	5	175	430	●	●	●	●
TFV10S511K	320	415	459	561	845	50	2.5	5	180	390	●	●	●	●
TFV10S561K	350	460	504	616	925	50	2.5	5	185	360	●	●	●	●
TFV10S621K	385	505	558	682	1025	50	2.5	5	190	320	●	●	●	●
TFV10S681K	420	560	612	748	1120	50	2.5	5	200	290	●	●	●	●
TFV10S751K	460	615	675	825	1240	50	2.5	5	210	270	●	●	●	●
TFV10S821K	510	670	738	902	1355	50	2.5	5	220	260	●	●	●	●

● : Approved ○ : Unauthorized ● : RoHS & REACH Compliant

Specification

Model	Limited Current	Rated Function Temp.	Fuse Temp. (°C)	Holding Temp.	Rated Voltage	
		T_f		T_h	AC	DC
	(A)	(°C)	(°C)	(°C)	(V)	(V)
TFV10S820K	5	145	140±2	121	250	50
TFV10S101K	5	145	140±2	121	250	50
TFV10S121K	5	145	140±2	121	250	50
TFV10S151K	5	145	140±2	121	250	50
TFV10S181K	5	145	140±2	121	250	50
TFV10S201K	5	145	140±2	121	250	50
TFV10S221K	5	145	140±2	121	250	50
TFV10S241K	5	145	140±2	121	250	50
TFV10S271K	5	145	140±2	121	250	50
TFV10S301K	5	145	140±2	121	250	50
TFV10S331K	5	145	140±2	121	250	50
TFV10S361K	5	145	140±2	121	250	50
TFV10S391K	5	145	140±2	121	250	50
TFV10S431K	5	145	140±2	121	250	50
TFV10S471K	5	145	140±2	121	250	50
TFV10S511K	5	145	140±2	121	250	50
TFV10S561K	5	145	140±2	121	250	50
TFV10S621K	5	145	140±2	121	250	50
TFV10S681K	5	145	140±2	121	250	50
TFV10S751K	5	145	140±2	121	250	50
TFV10S821K	5	145	140±2	121	250	50

Performance Curve (For reference only)

- Max. Peak Current Derating Curves

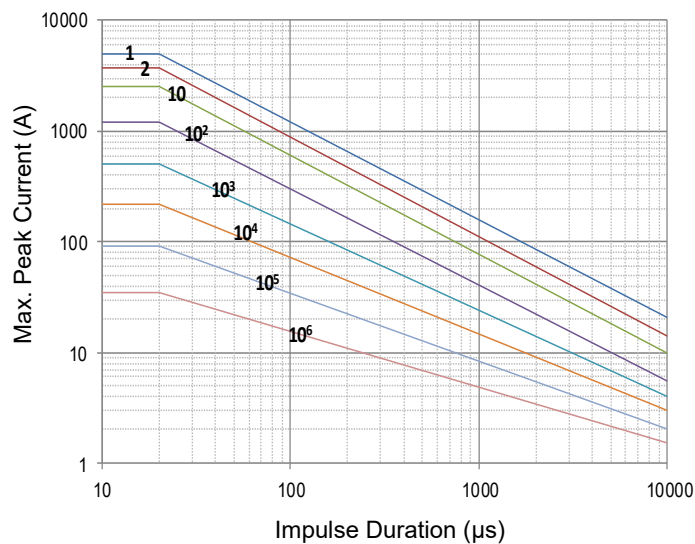

TFV10S820K to TFV10S821K

Note: 1, 2, 10, 10², 10³, 10⁴, 10⁵, 10⁶ Stand for Repetitions.

- Voltage-Current Characteristic Curves

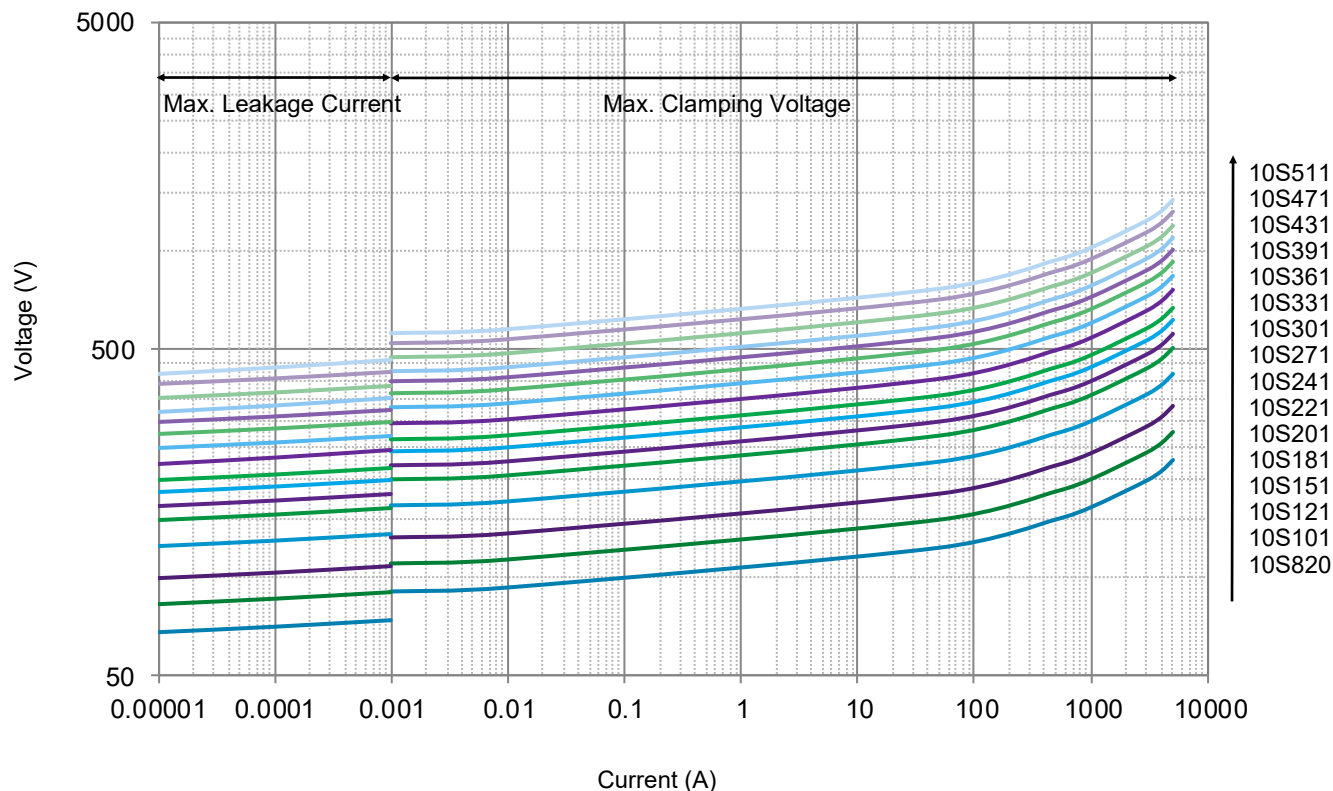

● Voltage-Current Characteristic Curves

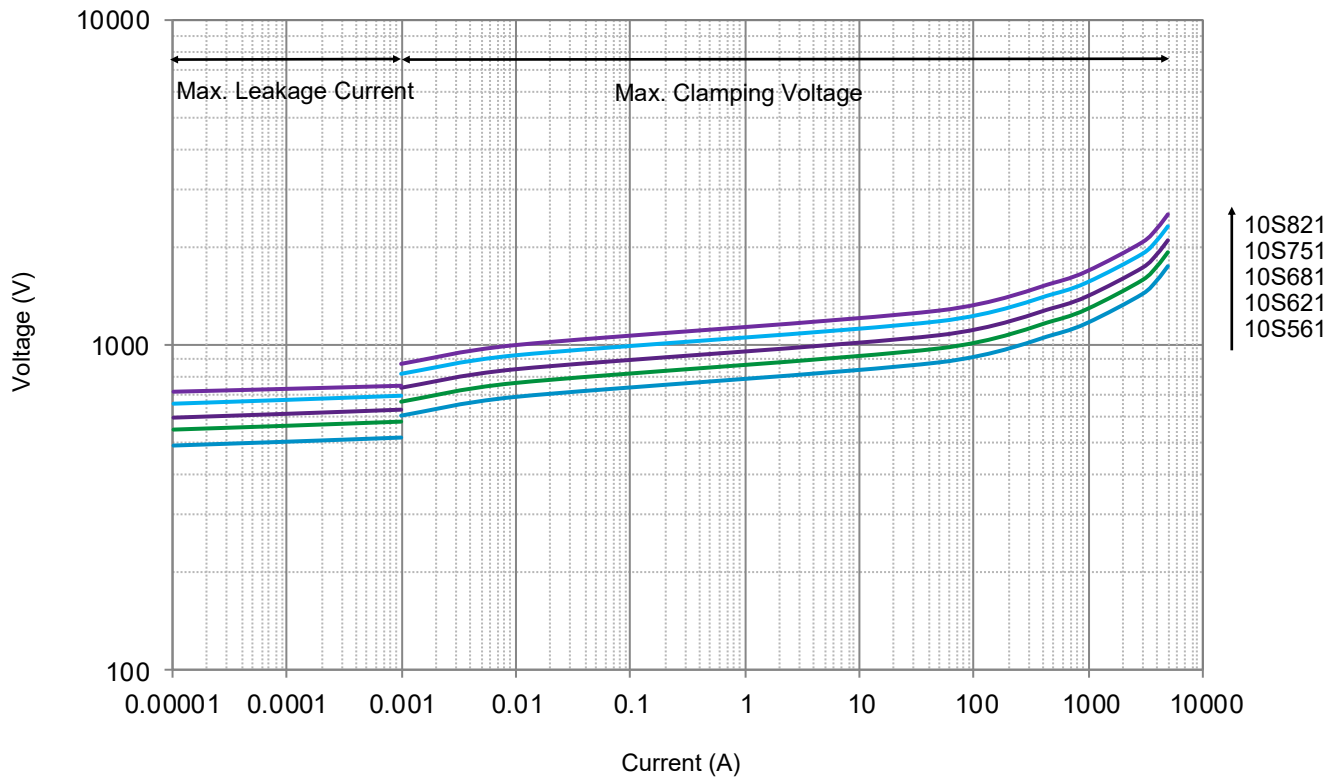

Soldering Parameters

Wave Soldering Parameters

The wave soldering parameters are for reference only. When MOV is for practice use, some related validation is recommended.

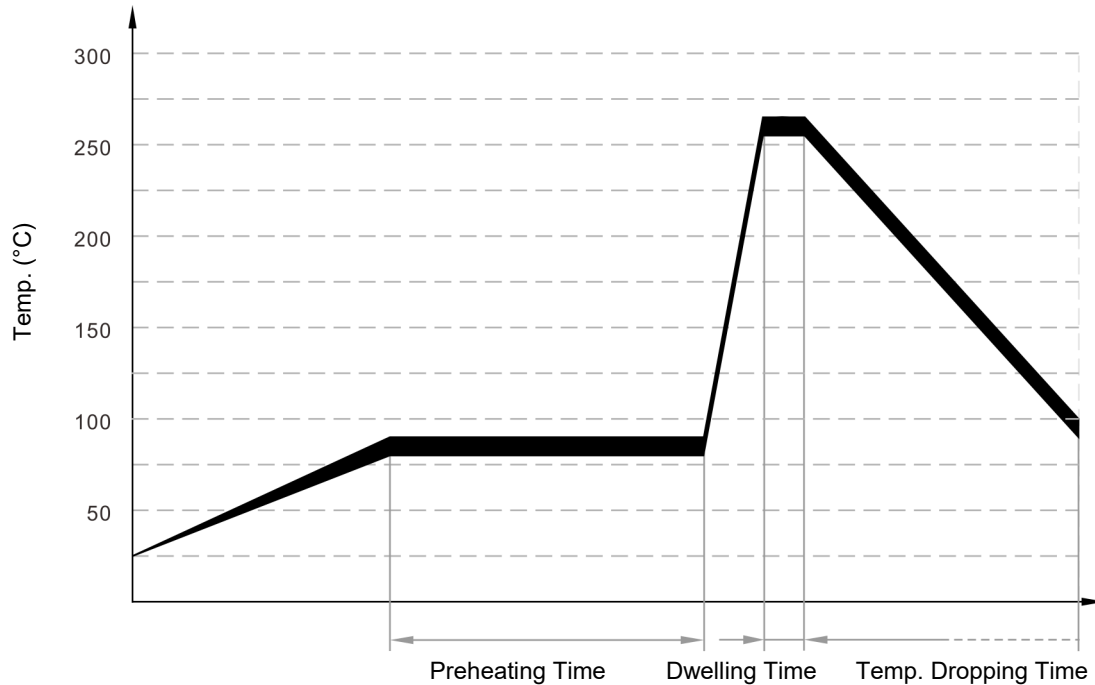

Wave Soldering Curve

Item	Temp. (°C)	Time (s)
Preheating	80 to 90	60 to 150
Dwelling	260 ± 5	2 to 4
Cooling Time	≤ 80	10

Recommended Hand-Soldering Parameters

Item	Condition
Temp. of Solder Head	350 °C (max.)
Soldering Time	2 seconds (max.)
Distance between Soldering Point and Coating	2 mm (min.)

Packaging Information

- Bulk Packaging
- Bulk Packaging Dimensions & Quantity

Series	Nominal Varistor Voltage (V_N)	PE Bag	Box	Carton	Gross Weight / Carton
	(V)	(PCS)	(PCS)	(PCS)	(kg)±10%
TFV10S Series	820 ~ 431	400	800	4800	9 ~ 13
	471 ~ 561	300	600	3600	10 ~ 12
	621 ~ 821	250	500	3000	12 ~ 15

Note:
Other lead length packaging information, please contact SETsafe | SETfuse.

All Dimensions in mm

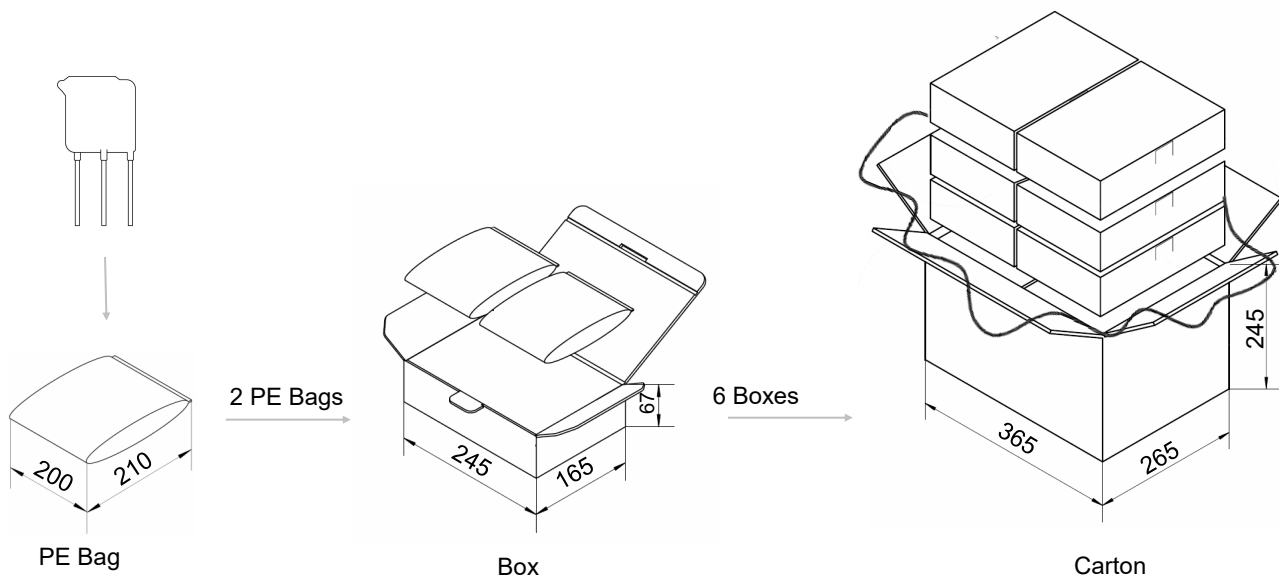

Part Numbering System

TFV 10 S 471 K 3 P K A BUL - 001

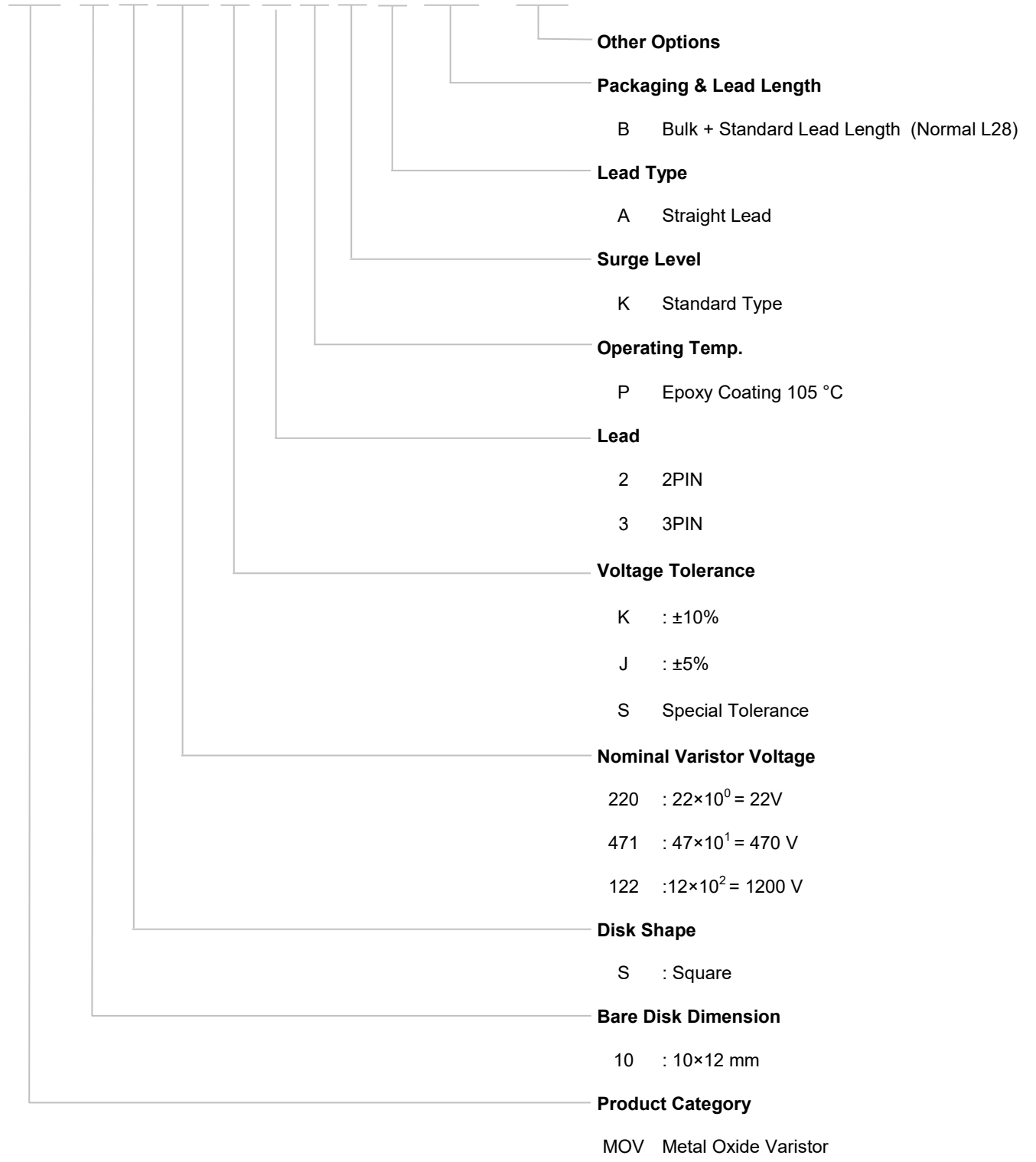

Glossary

Item	Description
V_N	Nominal Varistor Voltage Voltage, at specified D.C. current used as a reference point in the component characteristics. — (GB 18802.331) — (IEC 61051-1)
I_L	Leakage Current Measuring at 75% of varistor voltage. — (GB/T 10193) — (IEC 61051-1)
UCT	Upper Category Temp. Max. ambient temp. for which a varistor has been designed to operate continuously. — (GB/T 10193) — (IEC 61051-1)
LCT	Lower Category Temp. Minimum ambient temp. at which a varistor has been designed to operate continuously. — (GB/T 10193) — (IEC 61051-1)
Max. Peak Current	Max. Peak Current Max. current per pulse, which may be passed by a varistor at an ambient temp. of 25 °C, for a given number of pulses. — (GB/T 10193) — (IEC 61051-1)
V_C	Clamping Voltage Peak voltage developed across the varistor terminations under standard atmospheric conditions, when passing an 8/20 μ s class current pulse. — (GB 18802.331) — (IEC 61051-1)
Voltage Proof	Voltage Proof Max. peak voltage, which may be applied under continuous operating conditions between the varistor terminations and any conducting mounting surface (Applicable only to insulated varistors). — (GB/T 10193) — (IEC 61051-1)
C_V	Capacitance Capacitance across the MOV measured at a specified frequency and voltage. — (GB 18802.331) — (IEC 61051-1)
V_{ac}	Max. Continuous a.c. Voltage Max. a.c. r.m.s. voltage of a substantially sinusoidal waveform (less than 5% total harmonic distortion) which can be applied to the component under continuous operating conditions at 25 °C. — (GB/T 10193) — (IEC 61051-1)
V_{dc}	Max. Continuous d.c. Voltage Max. d.c. voltage (with less than 5% ripple) which can be applied to the component under continuous operating conditions at an ambient temp. of 25 °C. — (GB/T 10193) — (IEC 61051-1)
I_n	Nominal Discharge Current Crest value of the current through the SPD having a current waveshape of 8/20 μ s. — (GB 18802.1) — (IEC 61643-11)

Glossary

Item	Description
I_{max}	<p>Max. Discharge Current Crest value of a current through the SPD having an 8/20 μs waveshape and magnitude according to the manufacturers specification. I_{max} is equal to or greater than I_n.</p> <p>— (GB 18802.1) — (IEC 61643-11)</p>
T_f	<p>Rated function Temp. The Temp. of the TCO which causes it to change its state of conductivity with a detection current up to 10 mA as the only load.</p> <p>— (GB 9816) — (IEC 60691)</p>
T_h	<p>Holding Temp. The Max. temp. of product body surface at which a TCO will not change its state of conductivity when conducting rated current for 168 h.</p> <p>— (GB 9816) — (IEC 60691)</p>
U_r	<p>Rated Voltage The voltage used to classify a TCO, which is the maximum voltage that TCO allows to carry and is able to cut off the circuit safely.</p> <p>— (GB 9816)</p>

Attention

Usage

1. Please do not apply severe vibration, shock or pressure to avoid surface resin or element cracking.
2. Please fix lead wires when bending or cutting. The distance between the bending point and the sealing of MOV shall be greater than 2mm.
3. In order to reduce the surface temperature rise, adding heat insulated shroud is recommended before wave soldering.
4. This curve is for reference only. Please confirm before production to avoid damaging the integrated Thermal Fuse.

Replacement

1. If varistor is visually damaged, please replace it.
2. Varistor is a non-repairable product. For safety sake, please use equivalent varistor for replacement.

Storage

1. Storage Temp. Range: (-40 to +125) °C
2. Relative Humidity : ≤75% RH
3. Do not store the MOV at the high temp., high humidity or corrosive gas environment, to avoid influencing the solder-ability of the lead wires, the product shall be used up within 1 year after receiving the goods.

Environmental Conditions

1. Varistor should not be exposed to the open air, nor direct sunshine.
2. Varistor should avoid rain, water vapor or other condition of high temp. and high humidity.
3. Varistor should avoid sand dust, salt spray, or other harmful gases.

Max. Typical Capacitance of Varistor

The typical capacitance of varistor is listed in the specifications. Designers may refer to it when designing MOV in high frequency circuit.

Installation

Mechanical Stress

Do not knock MOV when installing, to avoid mechanical damage.

Please do not apply severe vibration, shock or pressure to MOV, to avoid surface resin or element cracking.

Application Examples

The application examples below show how the indicator lead on the TFV can be used to indicate that the thermal element has been opened. This signifies that the circuit is no longer protected from transients by the MOV.

1. In this case, the LED is normally on, and is off when the thermal element opens.
2. This circuit utilizes an optocoupler to provide galvanic isolations between the TFV varistor and the indicating or alarm circuitry.

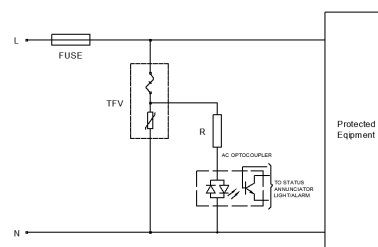
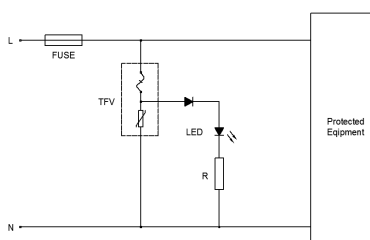

Thermal Fuse Varistor (TFV) Feature & Model List Overview

Nominal Operating Voltage U_n (V)		Model		Page	
				AC	DC
380V	500V	TFV10S821K	TFV15S821K	510	670
		TFV10S751K	TFV15S751K	460	615
100V		TFV10S681K	TFV15S681K	420	560
		TFV10S621K	TFV15S621K	385	505
240V		TFV10S561K	TFV15S561K	350	460
		TFV10S511K	TFV15S511K	320	415
100V		TFV10S471K	TFV15S471K	300	385
		TFV10S431K	TFV15S431K	275	350
220V		TFV10S391K	TFV15S391K	250	320
		TFV10S361K	TFV15S361K	230	300
100V	250V	TFV10S331K	TFV15S331K	210	275
		TFV10S301K	TFV15S301K	190	250
120V		TFV10S271K	TFV15S271K	175	225
		TFV10S241K	TFV15S241K	150	200
125V		TFV10S221K	TFV15S221K	140	180
		TFV10S201K	TFV15S201K	130	170
100V		TFV10S181K	TFV15S181K	115	150
		TFV10S151K	TFV15S151K	95	125
48V		TFV10S121K	TFV15S121K	75	100
		TFV10S101K	TFV15S101K	60	85
		TFV10S820K	TFV15S820K	50	65
AC	DC	5	10	AC	DC

Maximum Peak Current (8/20 μ s) (kA)